



Shenzhen XK Innovations Technology Co.,Ltd.

# X250 多功能四轴

---

## 使用说明书



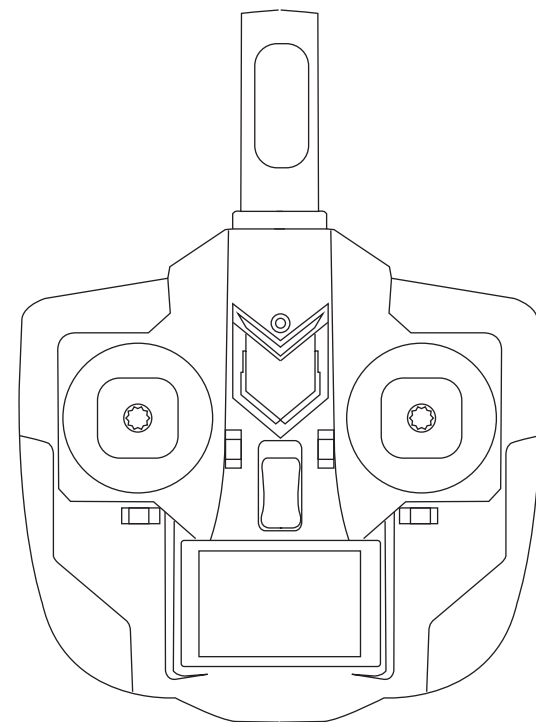







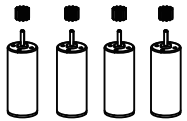

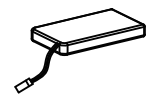
### INSTRUCTION MANUAL

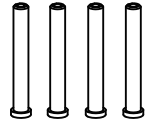

[WWW.XK-innovations.com](http://WWW.XK-innovations.com)

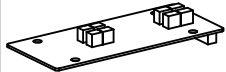
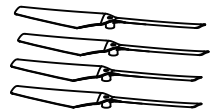
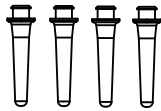
mail: [sales@xk-innovations.com](mailto:sales@xk-innovations.com)

## Accessories list 配件列表

Motor parts group 马达配件组	Screw fittings group 螺丝配件组	Battery Accessories Group 电池配件组	Shades Accessories Group 灯罩配件组
			
Bearing Components Group 轴承配件组	Spindle Accessories Group 主轴配件组	Body Parts Group 机身配件组	Body parts Group 2 机身2配件组
			
Gear Accessories Group 齿轮配件组	Motherboard Accessories Group 主板配件组	Propeller Accessories Group 螺旋桨配件组	Feet 2 Accessories group 脚垫2配件组
			
Shock circle Accessories group 避震圈配件组	Indicator Accessories Group 指示灯配件组	Ottomans Accessories Group 脚垫配件组	
			

## Standard Accessories 标准配件

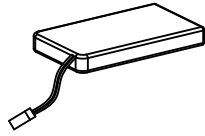
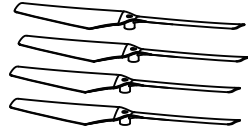
 Charger x1 充电器x1	 3.7V 780mah Li-po battery x 1 锂电池 x 1	 Blade x 4 风叶x4
--	--	--

## Packaging List 包装清单

NO	PART NAME	零件名称	QUANTITY
1	Instruction Manual	使用说明书	1
2	Aircraft	飞行器	1
3	Charger	充电器	1
4	Li-po battery	锂电池	1
5	Blades	正、反螺旋桨	4
6	Remote control	遥控器	1
7	Phillips screwdriver	十字螺丝刀	1

## Upgraded Parts 可升级配件

<p>X250-28 5.8G FPV</p> 	<p>X250-27 WIFI FPV</p> 
---	---

## Notice 注意事项

- All instructions, warranties and other collateral documents are subject to change at the sole discretion of our company. For the latest information please visit our company website [www.xk-innovations.com](http://www.xk-innovations.com)
- 所有的说明，本公司有权更改担保及其他相关文件的权利，更新的信息请访问

## Warning 警告

- Read the entire instruction manual to become familiar with the features of the product before operating. Failure to operate the product correctly can result in damage to the product, personal property and cause serious injury. This is a sophisticated hobby product and must be operated with caution, common sense and requires some basic mechanical ability. Failure to operate this product in a safe and responsible manner could result in injury, damage to the product or other property. This product is not intended for use by children without suitable adult supervision. The manual contains instructions for safety, operation and maintenance. It is essential to read and follow all the instructions and warnings, prior to assembly, setup or use in order to operate correctly and avoid damage or serious injury.

■ 操作前，请阅读整个说明书以便了解该产品的功能。未能正确地操作本产品可能会导致产品损坏，对人身财产造成严重损害。这是一个复杂的模型产品，而不是一玩具。不仅要谨慎操作，还需要具备操作常识和操作基础。若未能安全使用该产品，会毁坏该产品或者对人身，或者对其他财产造成损失。本产品不供没有成人监督下的儿童直接使用。本手册内容包括安全、操作、维护。因此，在装配，安装或使用产品前。我们必须阅读并遵守本手册中所有的提示和警告，以便正确操作，避免造成损伤或严重伤害。

## Additional Safety Precautions and Warnings 附加安全措施防范和警告

Age recommendation: Not suitable for children under 14 years of age, this is not a toy.

1. Always operate your model in open spaces away from full size vehicles, traffic and people.
  2. Follow the directions and warnings for this and any optional support equipment (chargers, rechargeable battery packs etc.)
  3. Make sure that keep all chemicals, small parts and anything electrical are kept out of the reach of children.
  4. The model is not designed to be exposed to water; avoid exposure to water as moisture can cause damage to the sensitive electronics.
  5. Do not put any model parts in your mouth as it could cause serious injury or even death.
  6. Do not operate your model with low transmitter batteries.
1. 年龄建议: 不适合14岁以下的儿童，这不是一个玩具。
2. 始终在开放的空间操作你的模型，远离车辆、交通和人。
  3. 必须仔细地遵循操作说明和警告，以及任何可选的支持设备。（充电器，可选充电电池等）
  4. 始终保持远离所有的化学品，细小部件跟用电设备需远离儿童接触。
  5. 应避免与水接触，尤其此设备的设计不具备防水功能；水汽也会导致电子产品损害。
  6. 切勿将模型的任何部件放在嘴里，因为它可能会导致严重受伤甚至死亡。
  7. 当发射机电池电压过低时切勿操作你的模型。

## Introduction 简介

- Thank you for choosing this XK product. This is a four-axis quadcopter that can fly outdoors. In order to make the quadcopter easier to control please carefully read the entire manual. Please keep the manual to hand for reference of future adjustments and maintenance.

感谢您选购XK产品！这是一台能在室外飞行的4轴飞行器，为了让您更方便，更容易操控飞行器，请您仔细阅读完此说明书，再操作此台飞行器，同时请您妥善保管这本说明书，作为日后调整及维修的参考。

- Before your first flight please take time to carefully read this manual as it contains important flight information which will help your first flight to be an enjoyable experience.

在你第一次飞行前，请花时间仔细阅读本手册含重要的飞行资料，这将有助便您的第一次飞行，成为一次伟大的历程。

## Table of Contents 目录

Accessories list 配件列表 .....	1
Standard Accessories & Upgrade Parts 标准配件 .....	2
Packing list 包装清单 .....	2
Notice 注意事项 .....	3
Warning 警告 .....	3
Additional Safety Precautions and Warnings 附加安全措施防范和警告 .....	3
Introduction 简介 .....	4
Table of Contents 目录 .....	4
Warning and Battery Guide 电池使用警告与向导 .....	5
Battery Charging 电池充电 .....	6
First Flight Preparation 飞前注意事项 .....	6
Binding Of Radio Transmitter and Receiver 遥控器与接收器的对频道 .....	7
Parts Name of Transmitter 遥控器各部位名称 .....	8
First Flight instruction 首次飞行指挥 .....	9
Fail Safe / Signal Loss .....	9
Roll and Flips .....	10
CF MODE 无头模式 .....	10
Gyro Callibration 无头模式X轴 Y轴校准 .....	10
Trouble shooting Guide 如何排除飞行中的异常 .....	10
Schematic circuit board 电路板示意图 .....	11
Exploded View 爆炸图 .....	12
Parts list 零件清单 .....	13
Aircraft parameters 飞行器参数 .....	13

## Warning and Battery Guide 池使用警告与向导



The Battery charger included with the X250 has been designed to safely charge the LiPo battery.

X250附带的电池充电器可以安全的给聚合物锂电池充电。

CAUTION: All instructions and warnings must be followed exactly. Mishandling of LiPo batteries can result in fire, personal injury and/or property damage.

1. By handling, charging or using the included LiPo battery you assume all risks associated with lithium batteries.
2. Do not exceed the recommended charge rate.
3. Never charge the LiPo battery unattended.
4. If the battery starts to balloon or swell at any time, please STOP using the battery immediately. If you are charging or discharging STOP and disconnect. Continuing to use, charge or discharge a battery that is ballooning or swelling can result in a potential fire hazard.
5. Always store the battery at room temperature in a dry area for the best results.
6. Always transport or temporarily store the battery in a temperature range of 4.5°C - 48.5°C.
7. Do not store the battery or model in a vehicle in direct sunlight. If stored in a hot vehicle the battery can be damaged or even catch fire.
8. Do not use a Ni-CD, Ni-MH or any other charger other than the supplied Li-Po charger. Failure to use the correct charger may cause fire resulting in personal injury and/or property damage.
9. Do not cover the warning labels with hook and loop strips (Velcro), or any other labels.

注意: 必须严格遵守所有的提示和警告, 不正确处理聚合物电池可能会:

1. 导致火灾、导致人生伤害或财产损失。
2. 通过处理, 充电或使用包括锂电池, 你承担所有与锂电池相关的风险。
3. 在任何时间如果电池开始膨胀, 请立即停止使用; 如果充电或放电, 终止和断开; 继续使用, 充电或放电的膨胀电池, 可能会导致火灾。
4. 电池始终储存在温室下, 在干燥的地方以取得最佳效果。
5. 始终运输或暂时存放在40~120华摄氏的温度范围内, 不要存放在模型车内或直射阳光下; 如果在热车中, 电池会被损坏, 甚至着火。
6. 切勿使用镍镉或镍氢电池充电器, 不兼容的充电器充电电池可能会引起火灾, 造成人生伤害和财产损失。
7. 电池电压过低时, 千万不要操作你的设备。

**Warning:** Do not use a 12V power supply, only use the original charger supplied from our company. Failure to do so could cause property damage and/or injury.

警告: 充电时建议使用原厂提供的电源充电器, 否则会导致财产损失和伤害发生。

**Notice:** If the voltage of the LiPo battery drops below 3V it may be damaged or discharged; please land immediately and charge the battery to avoid damaging the quadcopter or battery.

注意: 当低于 3V 时, 锂电池可能会被损坏, 或者可能不再接受充电; 飞机飞行时电池电压低于 3.3V 时, 飞行动力下降明显, 请立即降落并且及时给电池充电。

## Battery Charging 电器充电

1-cell 3.7V variable rate DC LiPo charger Instructions:

1节3.7V变量控制直流锂电充电器

Only charge with the supplied XK LiPo charger, never charge the LiPo battery unattended.

1. Plug the charger into the wall socket.
2. Plug the Lithium Polymer battery plug into the charger jack, as shown in figure below.
3. Turn on the wall socket.
4. The Charge LED indicator will change to Red to show the battery is charging.
5. When fully charged the charge indicator on the charger will change to Green.

说明:

用 **XK** 配送的飞碟专用充电器充电。将聚锂电池插头, 插入充电器插口。如图所示

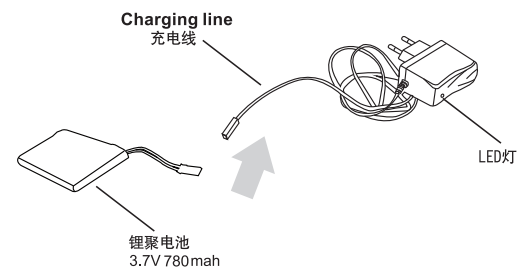

Only charge with the supplied XK LiPo charger, never charge the LiPo battery unattended.

注意: 只能使用 XK 提供的充电器

注意: 请勿尝试无任何交流转换直流装置。

## First Flight Preparation 飞前注意事项

1. Make sure the battery is fully charged.
2. Before connecting the battery make sure the throttle control stick is positioned downwards and the right control stick is in the centre.
3. If you are flying two quadcopters in the same location and experience problems turn one off and turn back on to rebind on a different frequency following the "Binding of transmitter and receiver" instructions.
4. Look for a suitable location to fly, away from crowds, cars, high-voltage towers, reservoirs, etc. Make sure you are safe and enjoy your flying.

1. 确认电源是否充足。
2. 打开电源开关时, 请确认油门摇杆在最下方。
3. 确认与飞行器是否同频, 如果异常请重新对码。
4. 寻找一个合适飞行的场地, 远离人群、车、高压电塔、水塘等, 方可进行安全愉快的飞行。

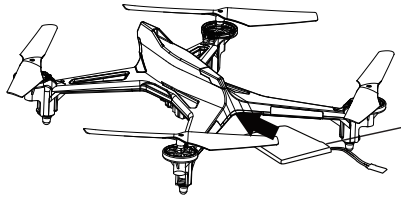

**Li-Po 锂聚电池 3.7V 780mah**

**Step 1 步骤 1**

Insert the battery into the quadcopter, the battery slides into the holder from the front to the back. Connect the battery up and place the quadcopter on a flat level surface. The X250 LED's will flash fast and then slow to a blink to show the quadcopter is ready bind to the handset.

将飞行器置于平坦位置后，将Li-po电池依图示方向推入电插座至定位，机身LED灯闪烁时不要再移动机身，使遥控器对频与陀螺仪读取中立点。

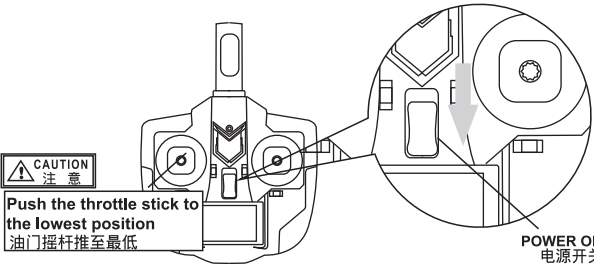

**CAUTION 注意**

**Push the throttle stick to the lowest position 油门摇杆推至最低**

**POWER ON/OFF 电源开关**

**Step 2 步骤 2**

Making sure the throttle control stick is positioned downwards turn on the transmitter. To activate the bind you have to move the throttle control stick full forwards and then back to the lowest position. On reaching the lowest position you will hear and audible "beep" from the transmitter and the LED's on the quadcopter will change from flashing to solid to show the quadcopter is bound and ready to fly.

打开遥控器电源开关，遥控器发出滴滴的响声，几秒钟后响声结束，同时机身LED常亮，对码完成。

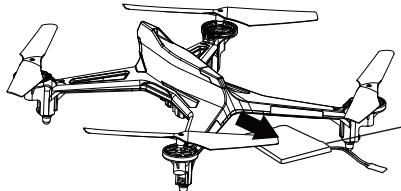

**Li-Po 锂聚电池 3.7V 780mah**

**Step 3 步骤 3**

After any flight the battery should be disconnected and removed from the quadcopter. This should be a post flight habit to avoid any unforeseeable problems.

结束飞行时，请将飞行器电池安全取下，请养成良好的习惯以免造成遗憾。

**Warning: If the LiPo battery is left connected in the quadcopter for long periods it may become damaged due to over-discharge or even become a potential fire hazard.**

电池未取下，将导致电池过放电而损坏，甚至造成起火燃烧的危险。

**WARNING 警告**

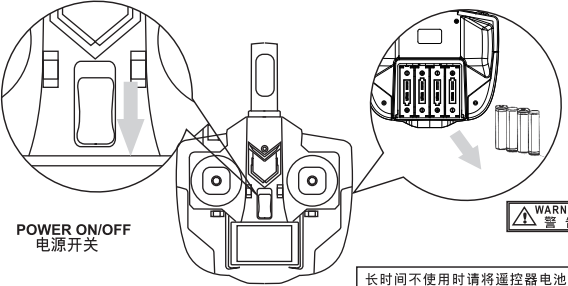

**POWER ON/OFF 电源开关**

**WARNING 警告**

**Step 4 步骤 4**

After flight and removal of the battery turn off the transmitter. If the transmitter is not going to be used for a long time you should remove and store the batteries.

关闭发射器电源，长时间不使用时请将遥控器电池取出并妥善保管。

**Warning: If the AA batteries are left in the transmitter for extended periods of time potential leakage could occur which may damage the transmitter and also create a fire hazard.**

电池未取下，将导致电池漏液而损坏遥控器，甚至造成起火燃烧的危险。

长时间不使用时请将遥控器电池取出并妥善保管。

**1. Transmitter Chart 遥控器面板外设说明**

Photo and Video functions are only applicable when you have a 5.8GHz Camera with a memory card connected.

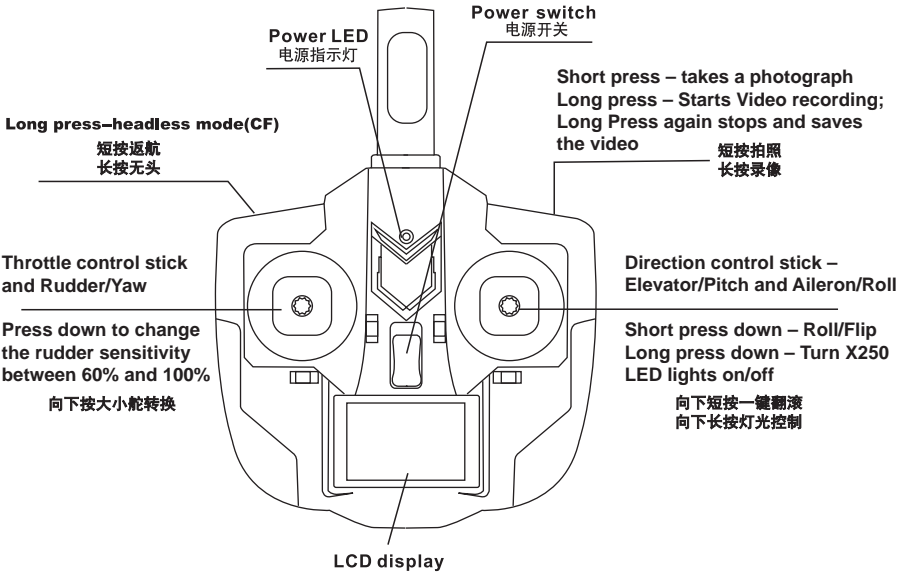

**Power LED 电源指示灯**

**Power switch 电源开关**

**Short press – takes a photograph Long press – Starts Video recording; Long Press again stops and saves the video**

**短按拍照 长按录像**

**Long press – headless mode (CF) 短按返航 长按无头**

**Throttle control stick and Rudder/Yaw**

**Direction control stick – Elevator/Pitch and Aileron/Roll**

**Press down to change the rudder sensitivity between 60% and 100% 向下按大小舵转换**

**Short press down – Roll/Flip Long press down – Turn X250 LED lights on/off 向下短按一键翻滚 向下长按灯光控制**

**LCD display 液晶面板**

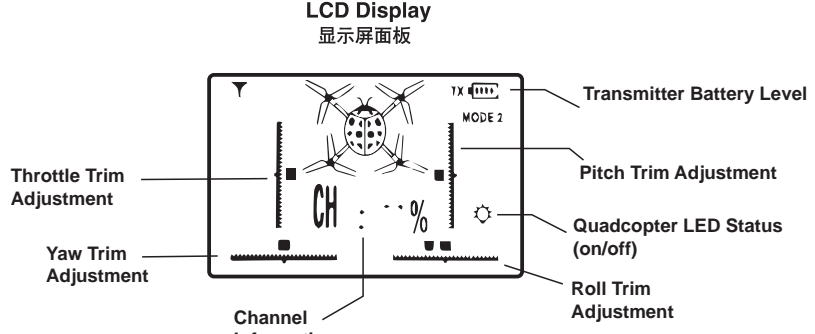

**LCD Display 显示屏面板**

**Transmitter Battery Level**

**Pitch Trim Adjustment**

**Quadcopter LED Status (on/off)**

**Roll Trim Adjustment**

**Throttle Trim Adjustment**

**Yaw Trim Adjustment**

**Channel Information**

## First Flight Instruction 首次飞行指挥

If you are not familiar with the controls of the X250 please take a few minutes to familiarize yourself with them before attempting your first flight.

如果你不熟悉X250的控制，花几分钟熟悉它们，然后尝试你的第一次飞行。

### Throttle 油门

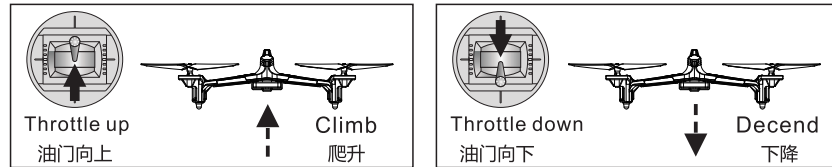

### Rudder / Yaw 方向

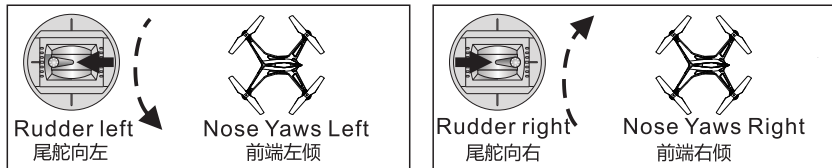

### Elevator / Pitch 升降

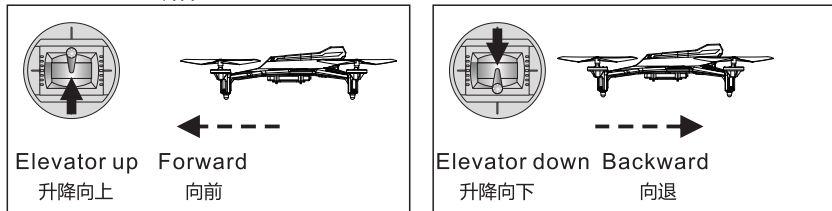

### Aileron / Roll 副翼

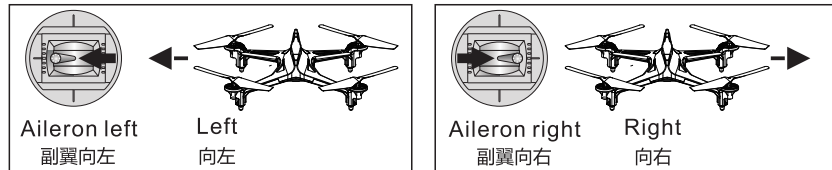

### Basic Flight Instructions

1. Make sure the LiPo battery is fully charged.
2. Insert the charged LiPo battery into the X250 and connect
3. Turn on the transmitter and follow the Binding of the Radio Transmitter and Receiver instructions.
4. Advance the throttle slowly to rise the X250 off the ground.
5. When the LiPo battery power starts to gets low, the LED's on the X250 will begin to blink indicating that it's time to land and recharge.
6. After becoming familiar with the flight controls of the X250 and gaining confidence you will be ready to move on to flips, rolls and faster forward flight.

## Fail Safe / Signal Loss

If the X250 loses connection with the transmitter, after 2-3 seconds the power to the motors will reduce and then cut to save the X260 from flying out of control. The LED's on the X250 will also begin to flash.

## Roll & Flips 3D翻滚

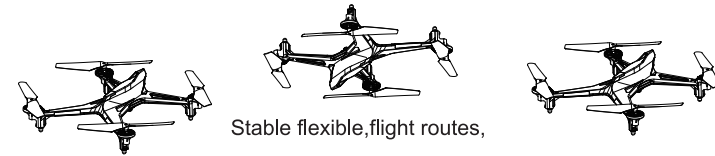

Stable flexible, flight routes,

飞行稳定、灵活、航线、甩尾、3D翻滚动作轻松实现

## CF MODE 无头模式

To active headless mode you have to press and hold down the CF button for 3 seconds. Once CF/Headless mode is active the transmitter will emit a slow constant beep to show it is in headless mode, the rear LED on the X250 will also flash to show headless mode is active.

Once in headless mode no matter which way the quadcopter is pointing, forward will always be forward, backwards will always be backwards, left will always be left and right will always be right.

把飞碟放在正前方，对码起飞后长按遥控器无头模式按键2秒进入无头模式同时遥控器发出的滴滴响声，再长按2秒退无头模式。注意：使用无头模式时必须在对码前把飞机放正（红桨朝正前方）！操控时人不能改变方向！

## Gyro/Accelerometer Calibration

If you experience any abnormal movements during flying you can recalibrate the X250's gyro.

To recalibrate the X250 place the X250 on a level surface and connect the battery.

Making sure the throttle control stick is positioned downwards turn on the transmitter.

To activate the bind move the throttle control stick full forwards and then back to the lowest position. On reaching the lowest position you will hear and audible "beep" from the transmitter and the LED's on the quadcopter will change from flashing to solid to show the quadcopter is bound.

Hold both control sticks to the bottom left, the LED's will all flash to show calibration is taking place, once the LED's stop flashing you can move the throttle stick back to the lowest centre position and the right stick to the centre. The X250 is then recalibrated and ready to fly.

## Troubleshooting Guide 如何排除飞行中的异常

	Situation 状况	Possible Cause 原因	Solution 对策
1	Quadcopter status LED's blink continuously for more than 4 seconds after the battery is connected. No Response from the control input	Unable to bind to the transmitter.	Repeat the power up sequence and rebind the Transmitter and Quadcopter
2	No response after the battery is connected to the Quadcopter	1. Battery is not charged. 2. Transmitter batteries are low 3. Poor battery connection	1. Make sure the battery is fully charged 2. Check and replace the transmitter batteries 3. Re-seat the battery to ensure a good battery connection
3	Motor does not respond to the throttle stick and the LED's flash	Quadcopter LiPo battery voltage is too low	Fully charge the battery or replace with a fully charged battery
4	Main rotor continues to spin after landing	Throttle trim has been accidentally knocked during flight	Check the throttle trim is in the centre or slightly below
5	Main rotor spins but quadcopter is unable to take off	1. Rotors are damaged 2. Battery is very low 3. Rotors incorrectly fitted	1. Replace the main rotors 2. Charge or replace with a fully charged battery 3. Check the rotors and correct if needed

6	Quadcopter has problems with inconsistent left/right manoeuvres	1. Damaged rotor(s) 2. Damaged motor(s)	1. Check and replace any damaged rotor(s) 2. Check and replace and damaged motor(s)
7	Strong vibrations on the quadcopter	Rotors damaged	Replace the main rotors
8	Quadcopter drifts after trim adjustment during hover	Gyro/Accelerometer is out of calibration	Perform the Gyro/Accelerometer calibration
9	The quadcopter fails to fly at all.	1. Motors damaged 2. Main gears loose	1. Replace damaged motor 2. Check and replace gears

### Schematic circuit board 电路板示意图

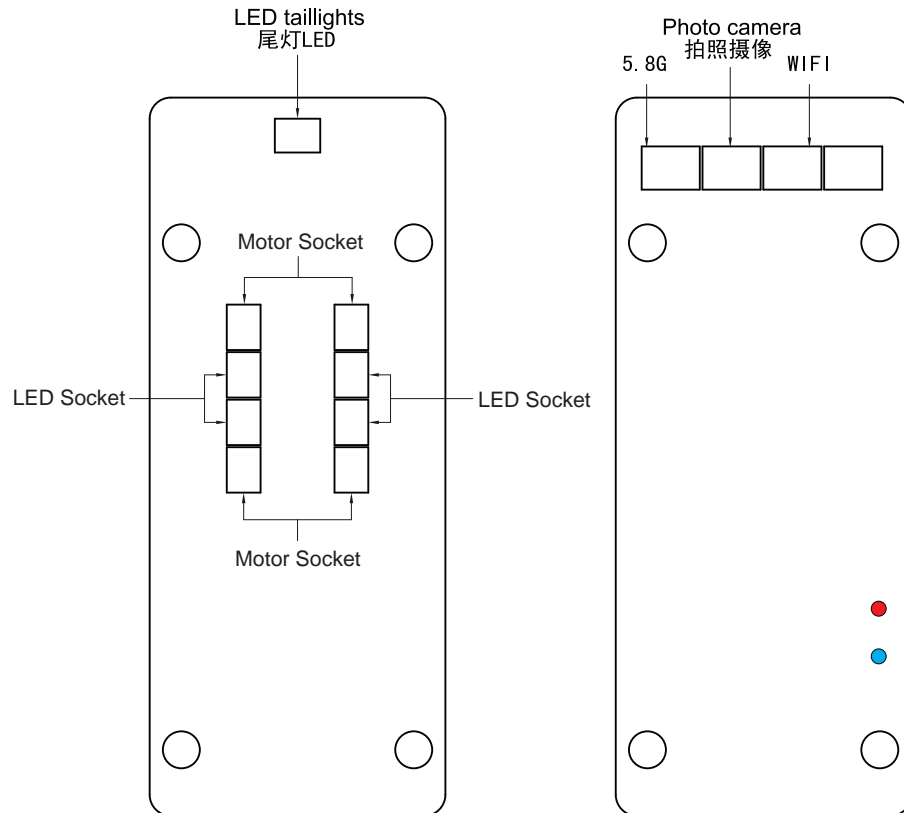

### Exploding View 爆炸图

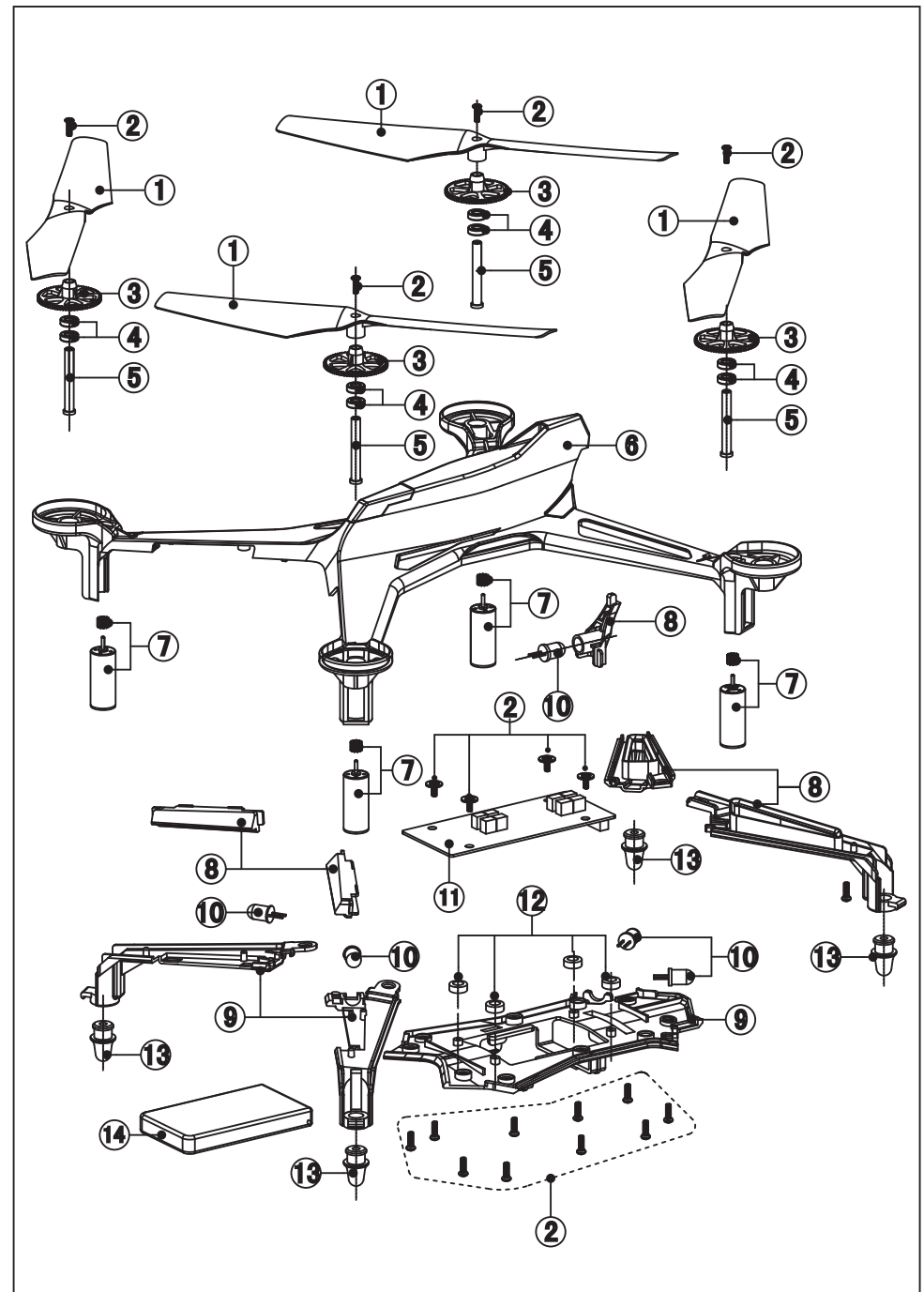

## Parts List 零件清单

NO	PART NAME	QUANTITY
X250-01	XK250 LIPO BATTERY 780MAH 3.7V	1
X250-02	XK250 MOTORS & GEAR (4)	4
X250-03	XK250 SCREW SET	1
X250-04	XK250 BEARING SET (4)	4
X250-05	XK250 ALUMINIUM MOTOR SHAFT	4
X250-06	XK250 MAIN GEAR SET (4)	4
X250-07	XK250 PCB BOARD	1
X250-08	XK250 PROPELLER SET (4)	4
X250-09	XK250 LED LIGHTS	1
X250-11	XK250 UPPER COVER GROUP	1
X250-12	XK250 DOWN COVER GROUP	1
X250-13	XK250 LIGHT GROUP	1
X250-14	XK250 FOOT PADS (4)	4
X250-15	XK250 FOOT PADS LONG (4)	1
X250-16	XK250 TRANSMITTER	1
X250-17	XK250 SCREW DRIVER	1
X250-18	XK250 CHARGER (UK)	1
X250-18E	XK250 CHARGER (EU)	1
X250-27	XK250 WIFI FPV SET	1
X250-28	XK250 5.8GHZ FPV SCREEN &	1
X250-29	XK250 CAMERA ONLY, 720P	1

## Helicopter Parameters 飞行器参数

Length	对角长度	240mm
Height	高度	66mm
Blade length	风叶长度	135mm
Battery Specification	电池规格	3.7V 780mAh20C
Flight time	飞行时间	10min